

PR

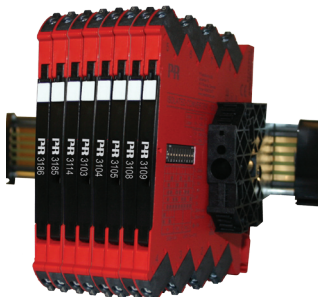

3118

**Bipolar isolated
converter/splitter**

No. 3118V100-UK

From ser. no 121330001



ATEX



SIGNALS THE BEST

- DK** ▶ PR electronics A/S tilbyder et bredt program af analoge og digitale signalbehandlingsmoduler til industriel automation. Programmet består af Isolatorer, Displays, Ex-barrierer, Temperaturtransmittere, Universaltransmittere mfl. Vi har modulerne, du kan stole på i selv barske miljøer med elektrisk støj, vibrationer og temperaturudsving, og alle produkter opfylder de strengeste internationale standarder. Vores motto »Signals the Best« er indbegrebet af denne filosofi – og din garanti for kvalitet.
- UK** ▶ PR electronics A/S offers a wide range of analogue and digital signal conditioning devices for industrial automation. The product range includes Isolators, Displays, Ex Interfaces, Temperature Transmitters, and Universal Devices. You can trust our products in the most extreme environments with electrical noise, vibrations and temperature fluctuations, and all products comply with the most exacting international standards. »Signals the Best« is the epitome of our philosophy – and your guarantee for quality.
- FR** ▶ PR electronics A/S offre une large gamme de produits pour le traitement des signaux analogiques et numériques dans tous les domaines industriels. La gamme de produits s'étend des transmetteurs de température aux afficheurs, des isolateurs aux interfaces SI, jusqu'aux modules universels. Vous pouvez compter sur nos produits même dans les conditions d'utilisation sévères, p.ex. bruit électrique, vibrations et fluctuations de température. Tous nos produits sont conformes aux normes internationales les plus strictes. Notre devise »SIGNALS the BEST« c'est notre ligne de conduite - et pour vous l'assurance de la meilleure qualité.
- DE** PR electronics A/S verfügt über ein breites Produktprogramm an analogen und digitalen Signalverarbeitungsmodulen für die industrielle Automatisierung. Dieses Programm umfasst Displays, Temperaturtransmitter, Ex- und galvanische Signaltrenner, und Universalgeräte. Sie können unsere Geräte auch unter extremen Einsatzbedingungen wie elektrisches Rauschen, Erschütterungen und Temperaturschwingungen vertrauen, und alle Produkte von PR electronics werden in Übereinstimmung mit den strengsten internationalen Normen produziert. »Signals the Best« ist Ihre Garantie für Qualität!

6 MM SERIES BIPOLAR ISOLATED CONVERTER/SPLITTER

3118

CONTENTS

Warning	2
Safety instructions.....	3
Mounting and demounting of system 3100	5
Installation on DIN rail	6
Marking.....	6
Side label.....	7
EC declaration of conformity	8
Applications.....	9
Technical characteristics	9
Mounting / installation.....	9
Order codes for 3118 and accessories.....	10
Specifications	10
Approvals	12
DIP-switch programming	12
Front LED (green) indications.....	12
Connections	13
Connections, bipolar output wiring set-up	13

WARNING



GENERAL

To avoid the risk of electric shock and fire, the safety instructions of this guide must be observed and the guidelines followed. The specifications must not be exceeded, and the device must only be applied as described in the following. Prior to the commissioning of the device, this installation guide must be examined carefully. Only qualified personnel (technicians) should install this device. If the equipment is used in a manner not specified by the manufacturer, the protection provided by the equipment may be impaired. Until the device is fixed, do not connect hazardous voltages to the device.

Repair of the device must be done by PR electronics A/S only.



**HAZARD-
OUS
VOLTAGE**

In applications where hazardous voltage is connected to in-/outputs of the device, sufficient spacing or isolation from wires, terminals and enclosure - to surroundings (incl. neighbouring devices), must be ensured to maintain protection against electric shock.



CAUTION

Potential electrostatic charging hazard. To avoid the risk of explosion due to electrostatic charging of the enclosure, do not handle the units unless the area is known to be safe, or appropriate safety measures are taken to avoid electrostatic discharge.

SYMBOL IDENTIFICATION



Triangle with an exclamation mark: Read the manual before installation and commissioning of the device in order to avoid incidents that could lead to personal injury or mechanical damage.



The CE mark proves the compliance of the device with the essential requirements of the directives.



Ex devices have been approved according to the ATEX directive for use in connection with installations in explosive areas.

SAFETY INSTRUCTIONS

RECEIPT AND UNPACKING

Unpack the device without damaging it. The packing should always follow the device until this has been permanently mounted. Check at the receipt of the device whether the type corresponds to the one ordered.

ENVIRONMENT

Avoid direct sunlight, dust, high temperatures, mechanical vibrations and shock, as well as rain and heavy moisture. If necessary, heating in excess of the stated limits for ambient temperatures should be avoided by way of ventilation.

All devices can be used for Measurement / Overvoltage Category II and Pollution Degree 2.

The device is designed to be safe at least under an altitude up to 2 000 m.

MOUNTING

Mounting and connection of the device should comply with national legislation for mounting of electric materials, i.e. wire cross section, protective fuse, and location. Descriptions of input / output and supply connections are shown in this installation guide and on the side label.

The device is provided with field wiring terminals and shall be supplied from a Power Supply having double / reinforced insulation. A power switch should be easily accessible and close to the device. The power switch shall be marked as the disconnecting unit for the device.

SYSTEM 3000 must be mounted on a DIN rail according to EN 60715.

UL installation

Use 60/75°C copper conductors only.

Wire size AWG 26-12

UL file number E314307

The device is an Open Type Listed Process Control Equipment. To prevent injury resulting from accessibility to live parts the equipment must be installed in an enclosure.

The power Supply unit must comply with NEC Class 2, as described by the National Electrical Code® (ANSI / NFPA 70).

cFmus installation in Division 2 or Zone 2

Class I, Div. 2, Group A, B, C, D T4 or I, Zone 2, AEx nA IIC T4 or Ex nA IIC T4.

In class I, Division 2 or Zone 2 installations, the subject equipment shall be mounted within a tool-secured enclosure which is capable of accepting one or more of Class I, Division 2 wiring methods specified in the National Electrical Code (ANSI/NFPA 70) or in Canada in the Canadian Electrical Code (C22.1).

The 3000 System Isolators and Converters must be connected to limited output NEC Class 2 circuits, as outlined in the National Electrical Code® (ANSI / NFPA 70), only. If the devices are connected to a redundant power supply (two separate power supplies), both must meet this requirement.

Where installed in outdoor or potentially wet locations the enclosure shall at a minimum meet the requirements of IP54.

Warning: Substitution of components may impair suitability for zone 2 / division 2.

Warning: To prevent ignition of the explosive atmospheres, disconnect power before servicing and do not separate connectors when energised and an explosive gas mixture is present.

Warning: Do not mount or remove devices from the power rail when an explosive gas mixture is present.

IECEX, ATEX installation in Zone 2

IECEX KEM 10.0068 X..... Ex nA IIC T4 Gc

KEMA 10ATEX0147 X..... II 3G Ex nA IIC T4 Gc

For safe installation the following must be observed. The device shall only be installed by qualified personnel who are familiar with the national and international laws, directives and standards that apply to this area.

Year of manufacture can be taken from the first two digits in the serial number.

The devices shall be installed in a suitable enclosure providing a degree of protection of at least IP54 according to EN60529, taking into account the environmental conditions under which the equipment will be used.

When the temperature under rated conditions exceeds 70°C at the cable or conduit entry point, or 80°C at the branching point of the conductors, the temperature specification of the selected cable shall be in compliance with the actual measured temperature.

Provisions shall be made to prevent the rated voltage from being exceeded by transient disturbances of more than 40%.

For installation on power rail in Zone 2, only Power Rail type 9400 supplied by Power Control Unit type 9410 is allowed.

To prevent ignition of the explosive atmospheres, disconnect power before servicing and do not separate connectors when energised and an explosive gas mixture is present.

Do not mount or remove devices from the power rail when an explosive gas mixture is present.

Cleaning

When disconnected, the device may be cleaned with a cloth moistened with distilled water.

MOUNTING AND DEMOUNTING OF SYSTEM 3100

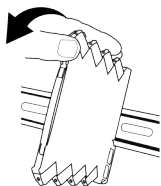

Picture 1:

Mounting on DIN rail.

Click the device onto the rail

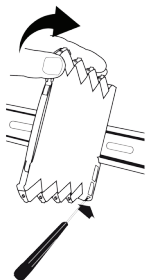

Picture 2:

Demounting from DIN rail

First, remember to demount the connectors with hazardous voltages.

Detach the device from the DIN rail by lifting the bottom lock.

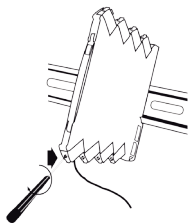

Picture 3:

Wire size AWG 26-12 / 0.13 x 2.5 mm² stranded wire.

Screw terminal torque 0.5 Nm.

INSTALLATION ON DIN RAIL

To avoid short circuit between the power rail connectors on the 3000 devices and the screws holding the 7.5 mm DIN rail, the head of the screws shall be no more than 3.5 mm high.

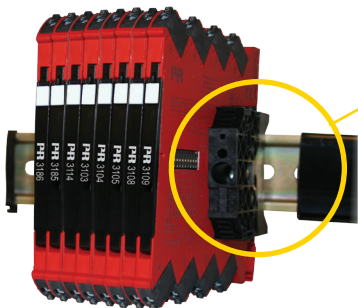
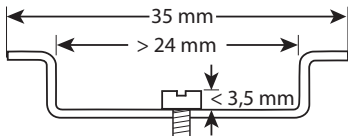

Module stop

3118 must be supported by module stops for marine applications.
(PR part number 9404).

MARKING

The front cover of the 3100 series has been designed with an area for affixation of a click-on marker. The area assigned to the marker measures 5 x 7.5 mm. Markers from Weidmüller's MultiCard System, type MF 5/7.5, are suitable.

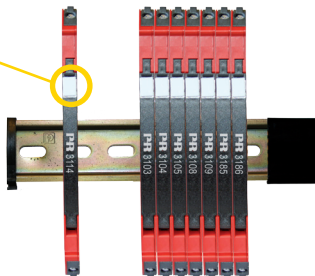

EC DECLARATION OF CONFORMITY

As manufacturer

PR electronics A/S
Lerbakken 10
DK-8410 Rønde

hereby declares that the following product:

Type: 3118

Name: Bipolar isolated converter/splitter

is in conformity with the following directives and standards:

The EMC Directive 2004/108/EC and later amendments

EN 61326-1 : 2006

For specification of the acceptable EMC performance level, refer to the electrical specifications for the devices.

The Low Voltage Directive 2006/95/EC and later amendments

EN 61010-1 : 2001

The ATEX Directive 94/9/EC and later amendments

EN 60079-0 : 2009 and EN 60079-15 : 2005

ATEX certificate: KEMA 10ATEX0147 X

Notified body

DEKRA Certification B.V. (0344)
Utrechtseweg 310, 6812 AR Arnhem
P.O. Box 5185, 6802 ED Arnhem
The Netherlands

Rønde, 1 October 2012



Kim Rasmussen
Manufacturer's signature

3118: BIPOLAR ISOLATED CONVERTER/SPLITTER

- *Conversion of voltage and current bipolar process signals to uni-/bipolar signals*
- *Multiple signal ranges are selectable via DIP-switches*
- *Splitter function: 1 signal in and 2 signals out*
- *Excellent accuracy, better than 0.05 % of selected range and high output load stability*
- *Slimline 6 mm housing*

Applications

- The 3118 is an isolating converter and splitter which can be used for signal conversion of standard bipolar analogue process signals into two individual unipolar analogue signals.
- The unit offers 4-port isolation and provides surge suppression and protects control systems from transients and noise.
- The 3118 also eliminates ground loops and can be used for measuring floating signals.
- Mounting of the 3118 can be in Safe area or in Zone 2 and Cl. 1 Div 2 area and is approved for marine applications.
- The analogue output can be easily configured and programmed to be bipolar in the ranges ± 10 mA and ± 20 mA (* see page 13).

Technical characteristics

- Flexible 24 VDC ($\pm 30\%$) supply via power rail or connectors.
- Excellent conversion accuracy, better than 0.05% of selected range.
- A green front LED indicates operation status for the device.
- All terminals are protected against overvoltage and polarity error.
- Meeting the NAMUR NE21 recommendations, the 3118 ensures top measurement performance in harsh EMC environments.
- High galvanic isolation of 2.5 kVAC.
- Fast response time < 7 ms / > 100 Hz bandwidth — 10 Hz bandwidth damping possible via DIP-switch.
- Excellent signal/noise ratio > 60 dB.

Mounting / installation

- Fast and easy configuration of factory calibrated measurement ranges via DIP-switches.
- A very low power consumption allows DIN rail mounting with up to 165 units per metre without the need for any air gap.
- Wide temperature operation range: $-25\dots+70^{\circ}\text{C}$.

Order codes for 3118:

Type	Specifications
3118	Bipolar isolated converter/splitter

Accessories for 3118:

Type	Function
3405	Power rail connector unit
9400	Power rail
9404	Module stop

Specifications

Environmental conditions:

Specifications range.....	-25°C to +70°C
Storage temperature	-40°C to +85°C
Calibration temperature.....	20...28°C
Relative humidity	< 95% RH (non-cond.)
Protection degree.....	IP20
Installation in pollution degree 2 & measurement / overvoltage category II	

Mechanical specifications:

Dimensions (HxWxD).....	113 x 6.1 x 115 mm
Weight approx.	70 g
DIN rail type.....	DIN EN 60715 - 35 mm
Wire size.....	0.13...2.5 mm ² / AWG 26...12 stranded wire
Screw terminal torque.....	0.5 Nm

Common electrical specifications:

Supply voltage, DC	16.8...31.2 VDC
Internal consumption, typ./max.	0.4 W / 0.65 W
Power consumption, max.	0.8 W
Isolation voltage, test	2.5 kVAC
Working isolation voltage.....	300 VAC / 250 VAC (Ex)
MTBF, acc. to 61709 (SN29500)	> 187 years
Signal / noise ratio	> 60 dB
Cut-off frequency (3 dB).....	> 100 Hz or 10 Hz (selectable via DIP-switch)
Response time (0...90%, 100...10%)	< 7 ms or < 44 ms

Input specifications:**Current input:**

Programmable ranges.....	± 10 and ± 20 mA
Functional range.....	-23 ... +23 mA
Input voltage drop.....	< 1 VDC @ 23 mA

Voltage input:

Programmable ranges.....	± 5 and ± 10 V
Functional range.....	-11.5 ... +11.5 V
Input resistance.....	≥ 1 M Ω

Output specifications:**Current output:**

Programmable ranges.....	0...20 and 4...20 mA
Functional range.....	0...23 mA
(*)Bipolar wiring and programming set-up.....	± 10 and ± 20 mA
Load (max.).....	23 mA / 300 Ω / per channel
Load stability.....	$\leq 0.002\%$ of span / 100 Ω
Current limit.....	≤ 28 mA

Voltage output:

Programmable ranges.....	0...5, 1...5, 0...10, 2...10 V
Functional range.....	0...11.5 V
Load	> 10 k Ω

of span = of the selected range

Accuracy values		
Input type	Absolute accuracy	Temperature coefficient
All	$\leq \pm 0.05\%$ of span	$\leq \pm 0.01\%$ of span / $^{\circ}$ C

EMC immunity influence	< $\pm 0.5\%$ of span
Extended EMC immunity: NAMUR NE 21, A criterion, burst	< $\pm 1\%$ of span

Approvals:

EMC 2004/108/EC	EN 61326-1
LVD 2006/95/EC.....	EN 61010-1
UL, Standard for Safety	UL 61010-1
Safe Isolation.....	EN 61140
GOST R	























Marine:

Det Norske Veritas, Ships & Offshore	Stand. f. Certific. No. 2.4
Germanischer Lloyd	VI-7-2

Ex:

ATEX 94/9/EC.....	KEMA 10ATEX0147 X
IECEX.....	KEM 10.0068 X
c FM us	3041043-C

DIP-switch configuration

DIP-switch positions are only read at power up (*) = bipolar wiring set-up	Output ch. 1 Current 0...20 mA 	Output ch. 2 Current 0...20 mA 
	Output ch. 1 Current 4...20 mA 	Output ch. 2 Current 4...20 mA 
Filter ON Bandwidth 10 Hz 	Output ch. 1 Current ± 20 mA set-up* 	Output ch. 2 Current ± 20 mA set-up* 
Filter OFF Bandwidth > 100 Hz 	Output ch. 1 Current ± 10 mA set-up* 	Output ch. 2 Current ± 10 mA set-up* 
Input Current -10...+10 mA 	Output ch. 1 Voltage 0...10 V 	Output ch. 2 Voltage 0...10 V 
Input Current -20...+20 mA 	Output ch. 1 Voltage 2...10 V 	Output ch. 2 Voltage 2...10 V 
Input Voltage -5...+5 V 	Output ch. 1 Voltage 0...5 V 	Output ch. 2 Voltage 0...5 V 
Input Voltage -10...+10 V 	Output ch. 1 Voltage 1...5 V 	Output ch. 2 Voltage 1...5 V 

Front LED indication (green)

LED	Condition	Outputs	Action required
OFF	No supply/device error	De-energized	Connect supply/replace device
1 flash 0.5 s ON and OFF	Power-up or Restart	De-energized	-
Flashing 13 Hz / 15 ms ON	Device OK	Energized	-
Flashing 1 Hz / 15 ms ON	Incorrect DIP-sw setting	De-energized	Correct setting and repower
Flashing 13 Hz / 0.5 s ON	Supply or hardware error	De-energized	Check supply/replace device

CONNECTIONS

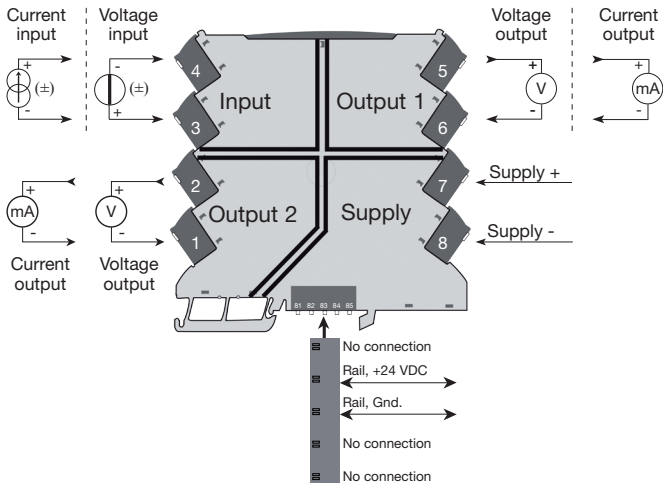

**Safe Area or
Zone 2 & Cl. 1, Div. 2, gr. A-D**

(*) Bipolar Input to bipolar output wiring set-up:

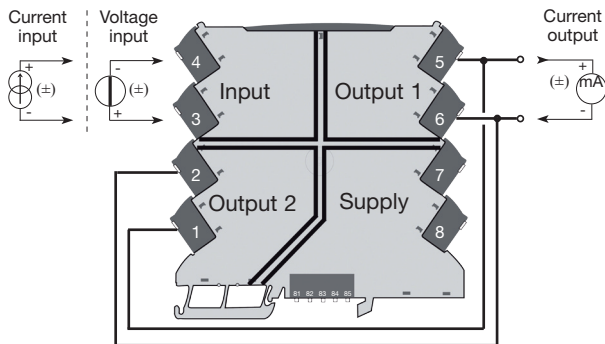



Displays Programmable displays with a wide selection of inputs and outputs for display of temperature, volume and weight, etc. Feature linearisation, scaling, and difference measurement functions for programming via PReset software.



Ex interfaces Interfaces for analogue and digital signals as well as HART® signals between sensors / I/P converters / frequency signals and control systems in Ex zone 0, 1 & 2 and for some modules in zone 20, 21 & 22.



Isolation Galvanic isolators for analogue and digital signals as well as HART® signals. A wide product range with both loop-powered and universal isolators featuring linearisation, inversion, and scaling of output signals.



Temperature A wide selection of transmitters for DIN form B mounting and DIN rail devices with analogue and digital bus communication ranging from application-specific to universal transmitters.



Universal PC or front programmable devices with universal options for input, output and supply. This range offers a number of advanced features such as process calibration, linearisation and auto-diagnosis.



PR



www.preelectronics.fr
sales@preelectronics.fr



www.preelectronics.de
sales@preelectronics.de



www.preelectronics.es
sales@preelectronics.es



www.preelectronics.it
sales@preelectronics.it



www.preelectronics.se
sales@preelectronics.se



www.preelectronics.co.uk
sales@preelectronics.co.uk



www.preelectronics.com
sales@preelectronics.com



www.preelectronics.cn
sales@preelectronics.cn

Head office

Denmark
PR electronics A/S
Lerbakken 10
DK-8410 Rønede

www.preelectronics.com
sales@preelectronics.dk
tel. +45 86 37 26 77
fax +45 86 37 30 85



QUALITY SYSTEM AND ENVIRONMENTAL MANAGEMENT SYSTEM
DS/EN ISO 9001
DS/EN ISO 14001

